



6+



3



0,7m



1 = 0m 2 = 0m 3 = 0m



Handicap moteur



Handicap sensoriel

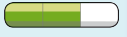

Handicap mental

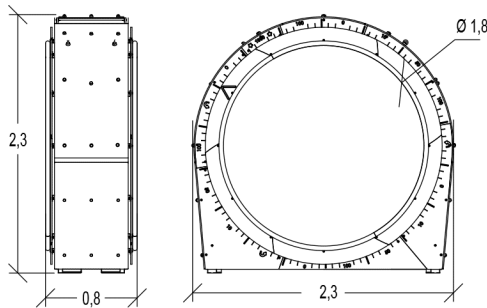
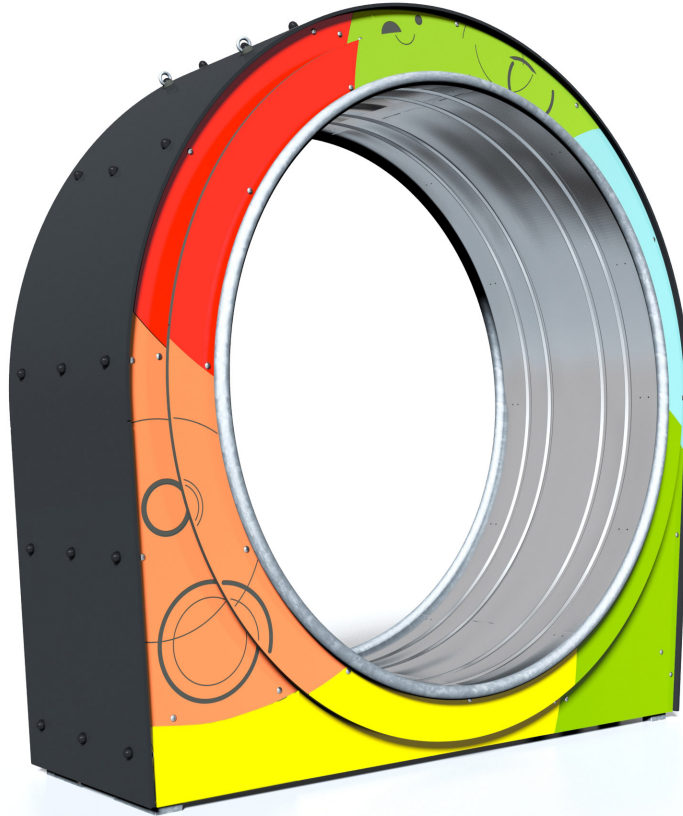

Fonctions ludiques : 5

se rencontrer



s'Équilibrer



tourner



stimulation visuelle



rÉflÉchir



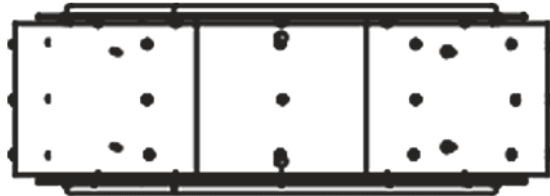



Installation de l'équipement

Zone d'impact : Surface de sol minimale requise

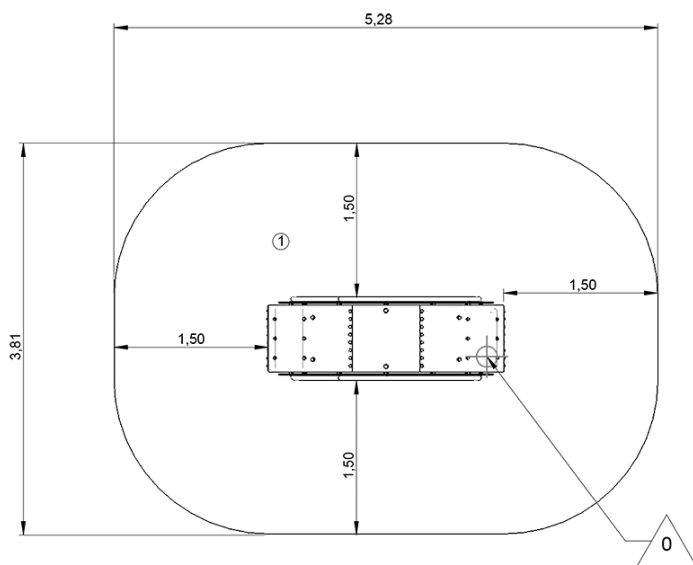
-  Zone d'impact
-  Espace libre



	
1	0,7m
	21m ²



2



04h00



0.5m³



21m²



396kg



358kg

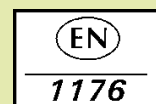

Proludic

0000-00-00