

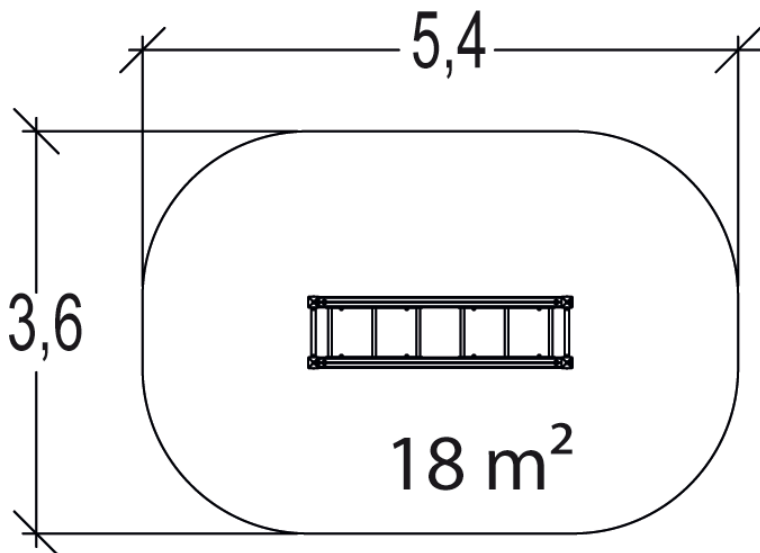

1=2.4m 2=0.6m 3=2.5m



INSTALLATION



00h00

INFOS DIVERSES



2 joueurs

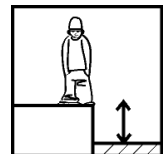

HCL= 1.4m

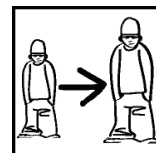

14+

CERTIFICATIONS

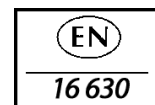

Poids total = 150 kg

Élément le + lourd = 22 kg