

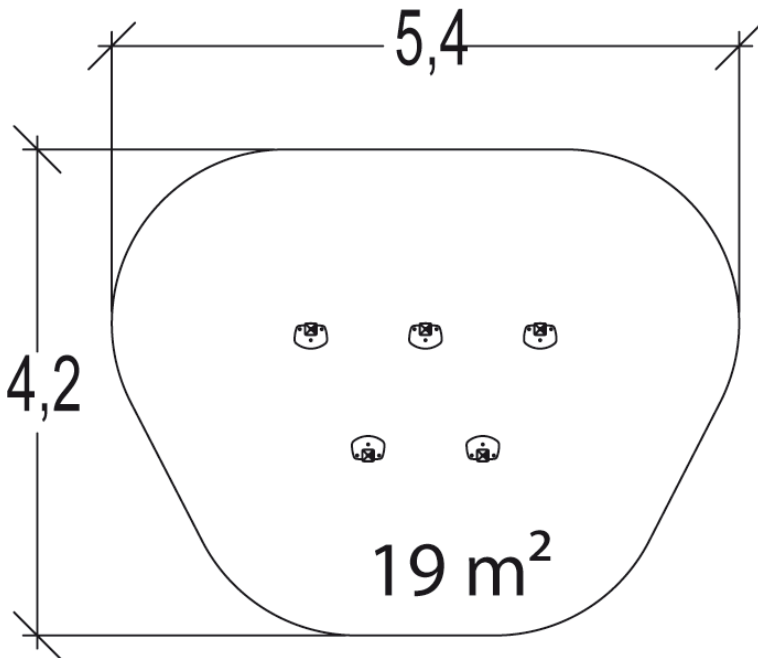

1=2.3m 2=1.2m 3=2.2m



INSTALLATION



00h00

INFOS DIVERSES



2 joueurs

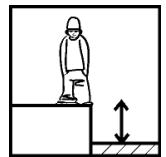

HCL= 0.55m

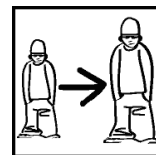

6+

CERTIFICATIONS

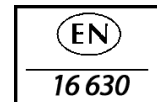

Poids total = 109 kg

Élément le + lourd = 20 kg