



1-5



1



0,46m



1 = 0,97m 2 = 0,46m 3 = 0,83m



Handicap moteur

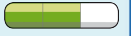

Handicap sensoriel



Handicap mental

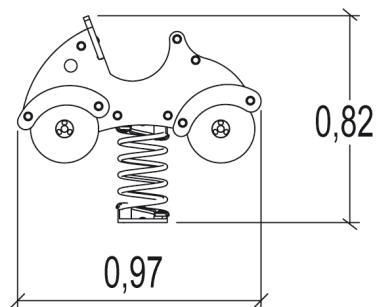
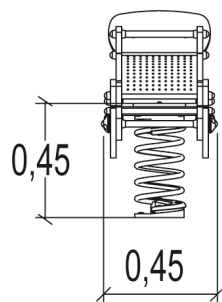
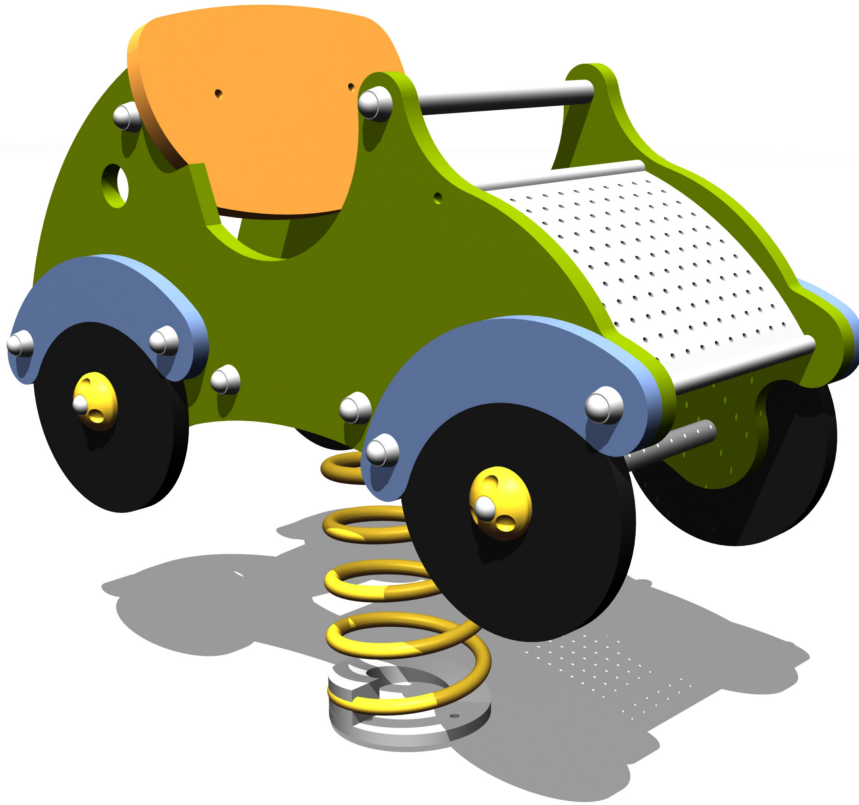

Fonctions ludiques : 3

se balancer



s'Ã©quilibrer



se rencontrer / fabuler



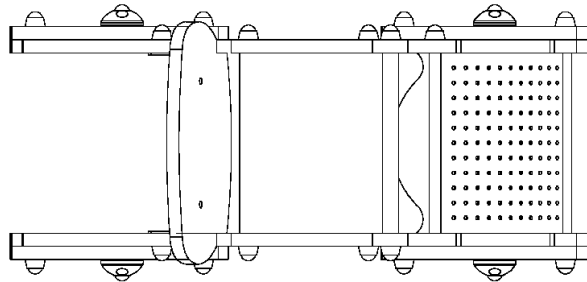



Installation de l'équipement

Zone d'impact : Surface de sol minimale requise

-  Zone d'impact
-  Espace libre

		
1	0,46m	7,5m ²

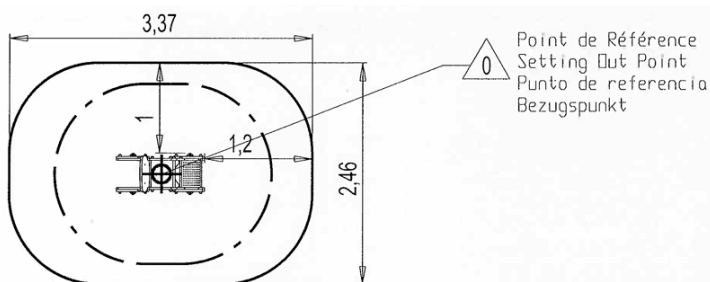

1



01h15



0m³



7.5m²



38kg



11kg

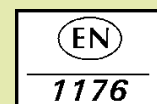

Proludic

2003-10-16