



1-8



6



0,6m



1 = 1,75m 2 = 1,26m 3 = 1,94m



Handicap moteur



Handicap sensoriel

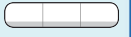

Handicap mental

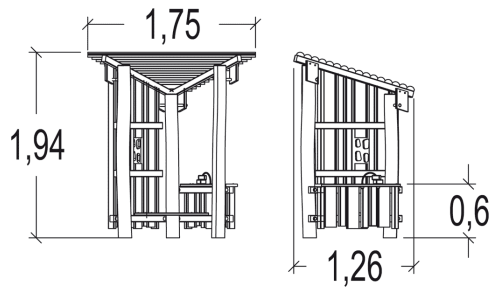
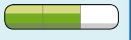

Fonctions ludiques : 5

fabuler



x1

se rencontrer



x1

se reposer



x1

manipuler



x1

s'abriter



x1

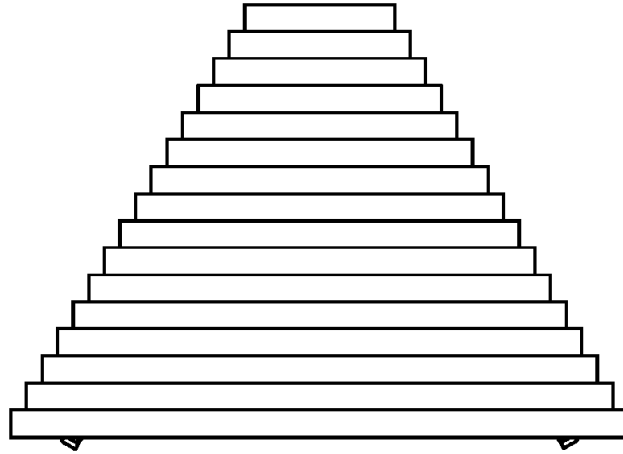



## Installation de l'équipement

**Zone d'impact : Surface de sol minimale requise**

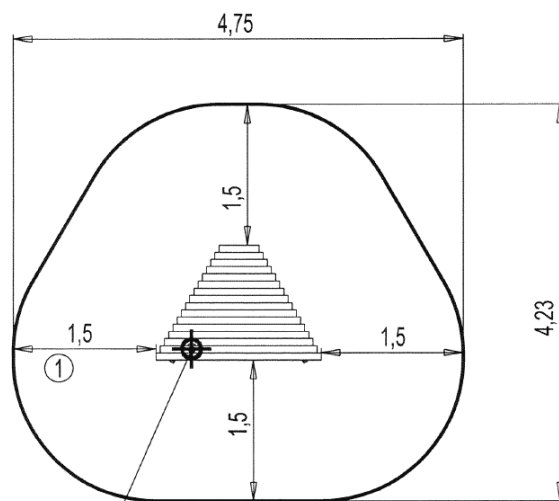
-  Zone d'impact
-  Espace libre



①  
 Point de Référence  
 Setting Out Point  
 Punto de referencia  
 Bezugspunkt  
 Referentiepunt

		
1	<0,6m	16m <sup>2</sup>



2



00h00



0m<sup>3</sup>



16m<sup>2</sup>



190kg



35kg

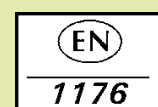

*Proludic*

2014-05-19