



6+



20



2,9m



1 = 8,3m 2 = 1,9m 3 = 4,2m

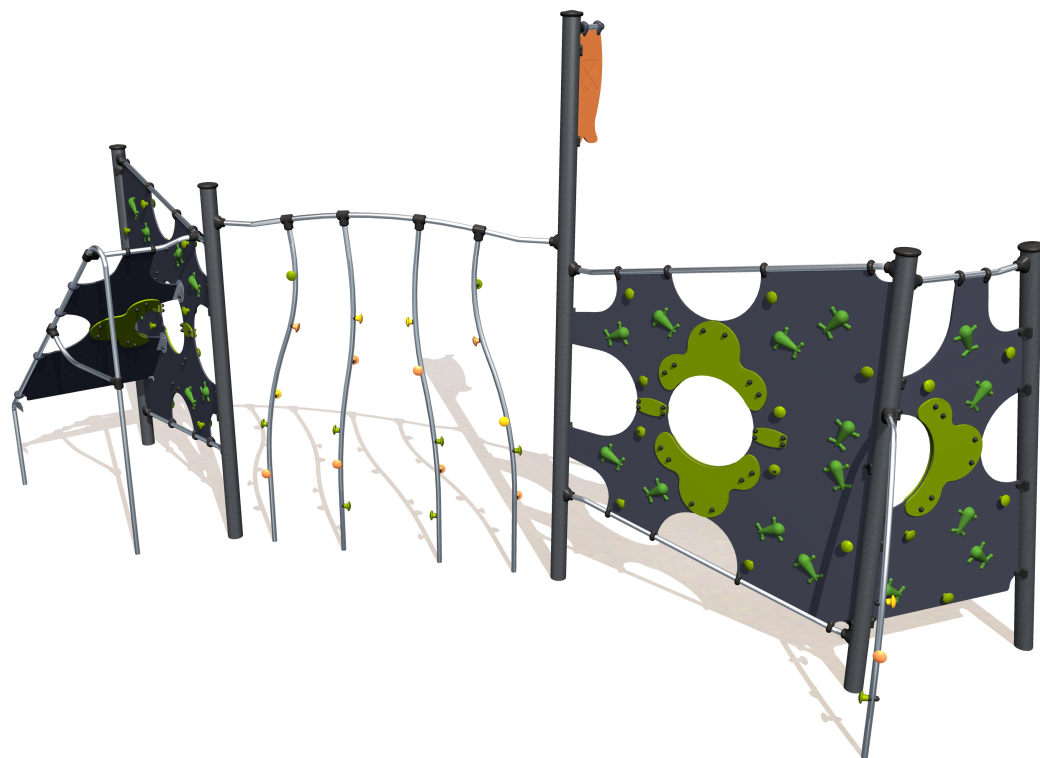

Fonctions ludiques : 5

escalader



x5

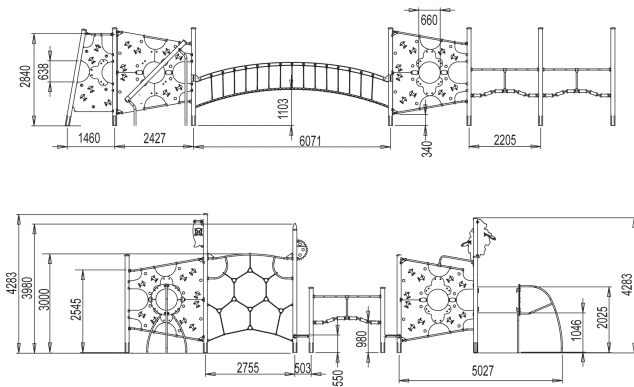



- ① Le losange
- ② L'oblique
- ③ Le vertical
- ④ Poteau thématisé Médiéval
- ⑤ Tubes à escalader
- ⑥ Mât à grimper





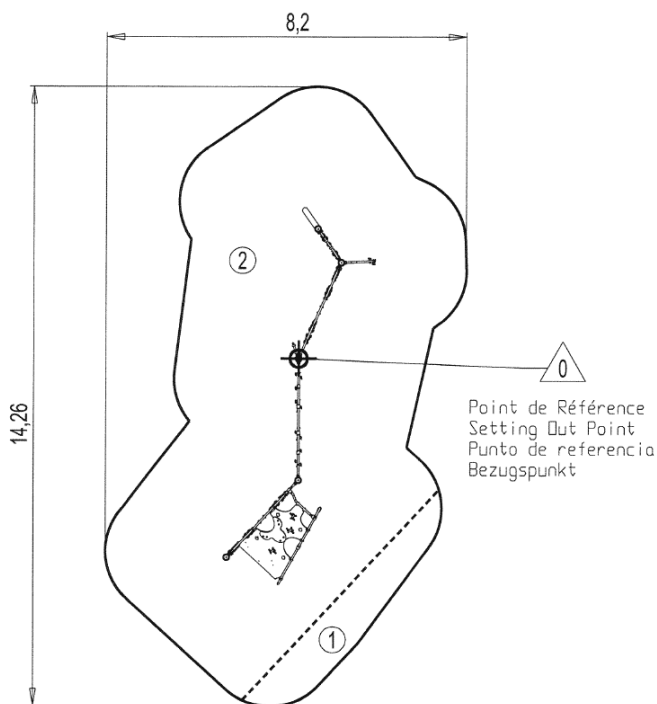

Installation de l'équipement

Zone d'impact : Surface de sol minimale requise

-  Zone d'impact
-  Espace libre



		
1	2,6m	5,5m ²
2	2,9m	71,5m ²

-  4
-  08h00
-  0.5m³
-  77m²
-  533kg
-  36kg

NF	S52-401
PAS	35

Proludic

0000-00-00