



2+



24



1,17m



1 = 4,83m 2 = 3,66m 3 = 2,93m

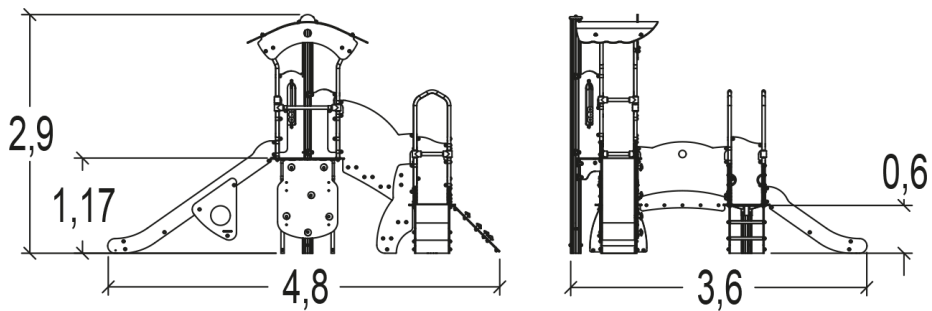

Fonctions ludiques : 10

escalader



x1

glisser



x1

se rencontrer



x2

se reposer



x1

manipuler



x1

s'abriter



x1

grimper



x3

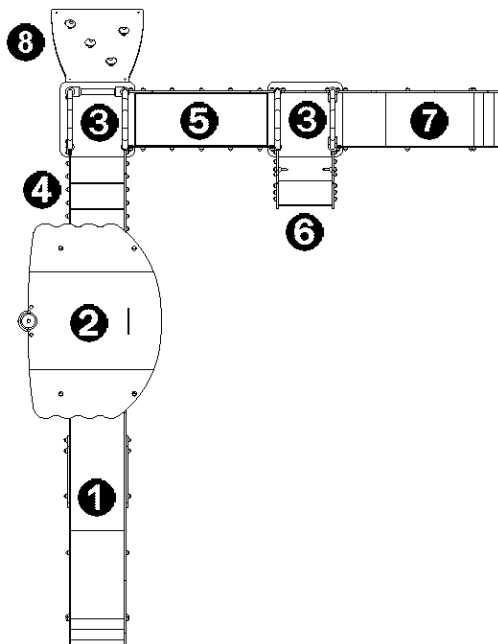



- ❶ Toboggan Ht : 1,17 m
- ❷ Tour H : 1,17 m
- ❸ Plate-forme H : 0,6 m
- ❹ Escalier intermédiaire
- ❺ Passerelle
- ❻ Escalier
- ❼ Toboggan H : 0,6 m
- ❽ Pan incliné
- ❾ Mur d'escalade

Installation de l'équipement

Zone d'impact : Surface de sol minimale requise

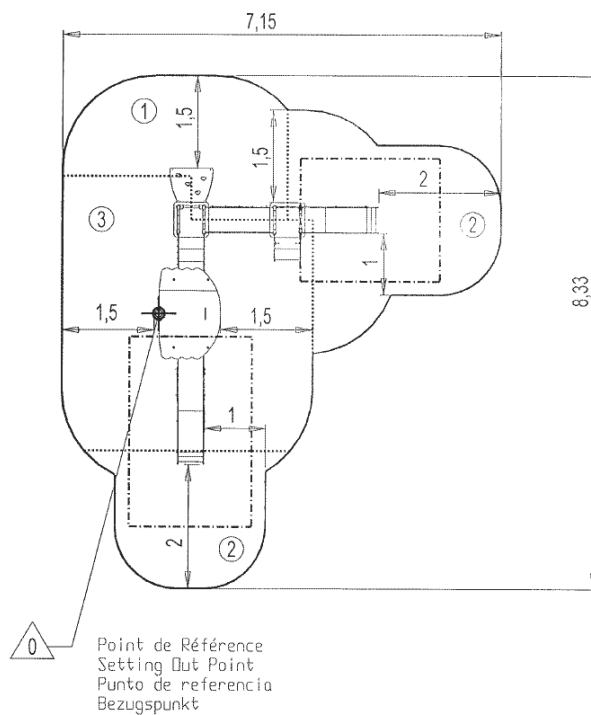
-  Zone d'impact
-  Espace libre



		
1	0,6m	6,5m ²
2	1m	14,5m ²
3	1,17m	17m ²



2



22h00



0.25m³



38m²



367kg



33kg

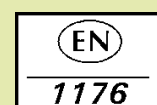

Proludic

0000-00-00