



2-10



15



1,17m



1 = 4,28m 2 = 1,29m 3 = 2,9m



Handicap moteur

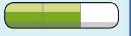

Handicap sensoriel

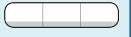

Handicap mental

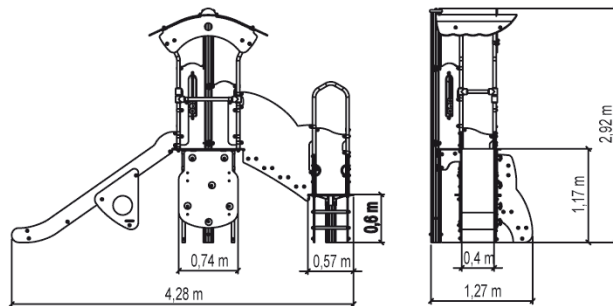

Fonctions ludiques : 9

escalader



x1

glisser



x1

se rencontrer



x2

se reposer



x1

manipuler



x1

s'abriter



x1

grimper



x2

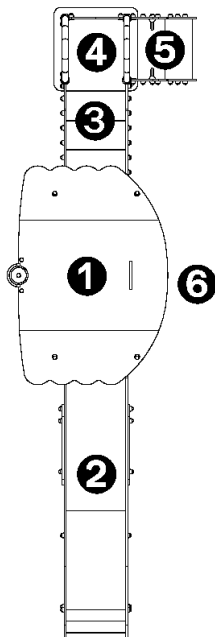



- ① Tour H : 1,17 m
- ② Toboggan Ht : 1,17 m
- ③ Escalier intermédiaire
- ④ Plate-forme H : 0,6 m
- ⑤ Escalier
- ⑥ Mur d'escalade

Installation de l'équipement

Zone d'impact : Surface de sol minimale requise

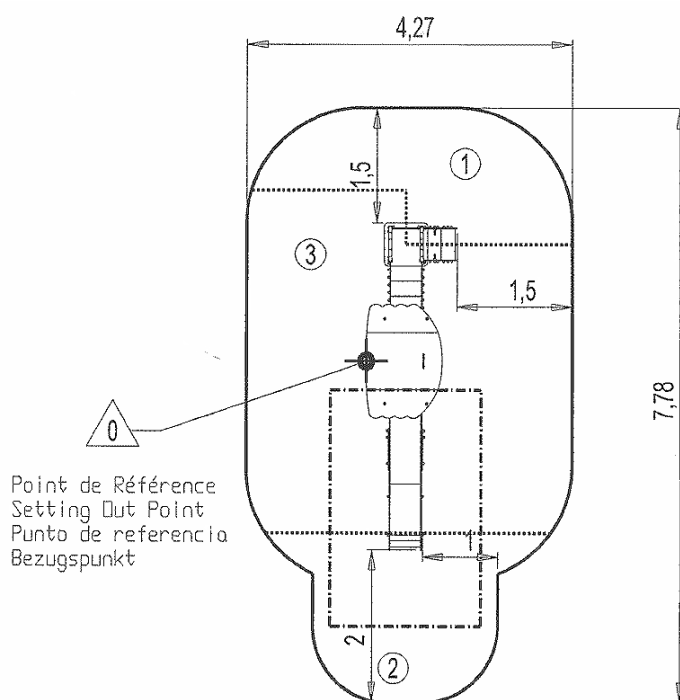
-  Zone d'impact
-  Espace libre



		
1	0,6m	5,5m ²
2	1m	5,5m ²
3	1,17m	17,5m ²



2



12h00



0.15m³



28.5m²



277kg



33kg

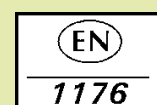

Proludic

2009-01-01