



1-8



7



0,55m



1 = 2,6m 2 = 2,4m 3 = 2m



Handicap moteur

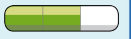

Handicap sensoriel



Handicap mental

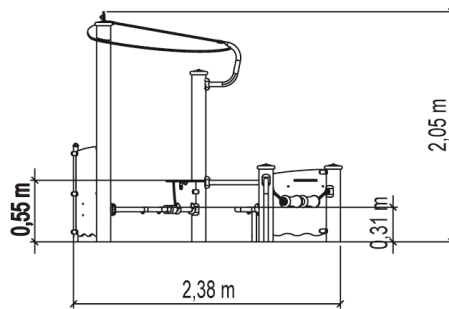
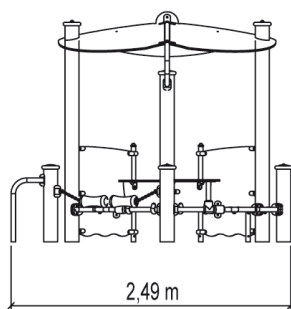
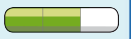

Fonctions ludiques : 8

fabuler



x1

se rencontrer



x3

se reposer



x3

s'abriter



x1

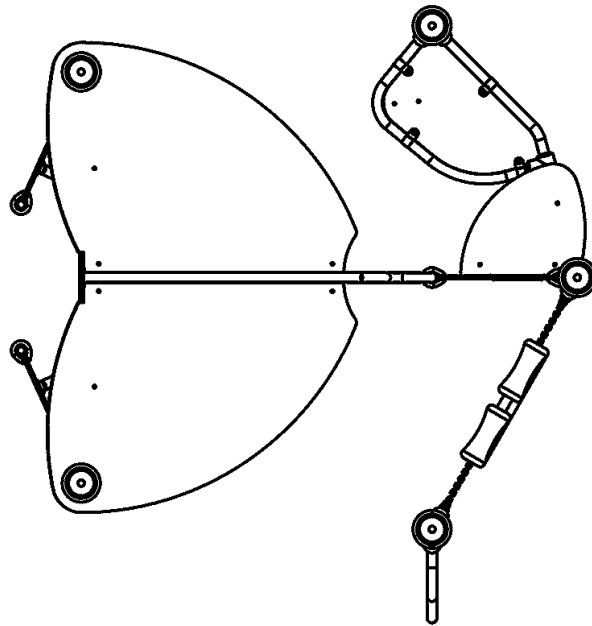







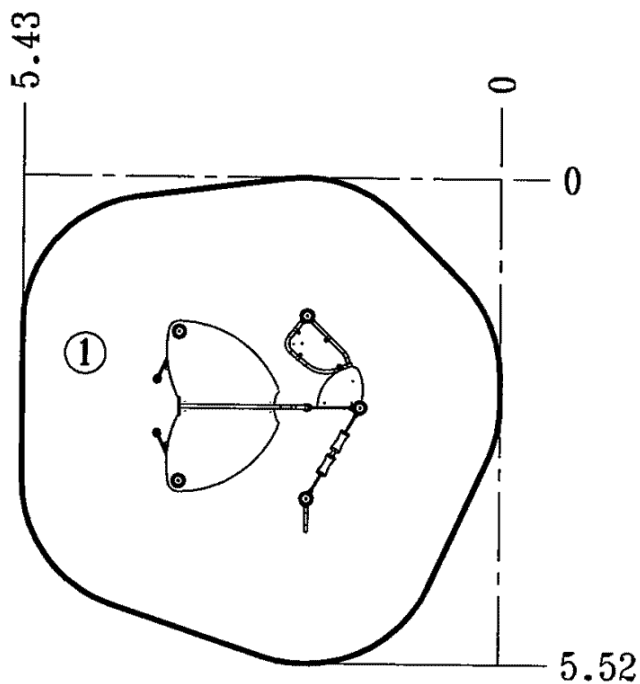

## Installation de l'équipement

Zone d'impact : Surface de sol minimale requise

-  Zone d'impact
-  Espace libre



		
1	0,55m	24,5m <sup>2</sup>

					
2	03h00	0.5m <sup>3</sup>	24.5m <sup>2</sup>	218kg	19kg

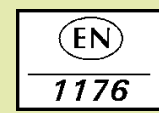

2007-01-01