



2+



60



2m



1 = 19m 2 = 17,4m 3 = 6,6m



Handicap moteur

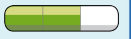

Handicap sensoriel

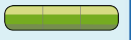

Handicap mental

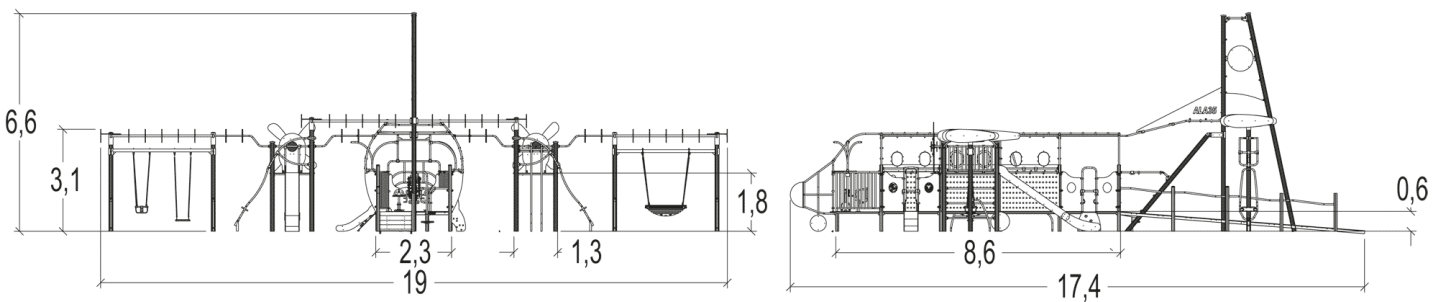
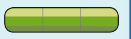

Fonctions ludiques : 14

fabuler



x1

glisser



x2

se rencontrer



x1

se reposer



x1

manipuler



x1

se balancer



x1

se cacher



x1

tourner



x2

stimulation sonore



x1

stimulation tactile



x1

stimulation visuelle



x1

grimper



x1

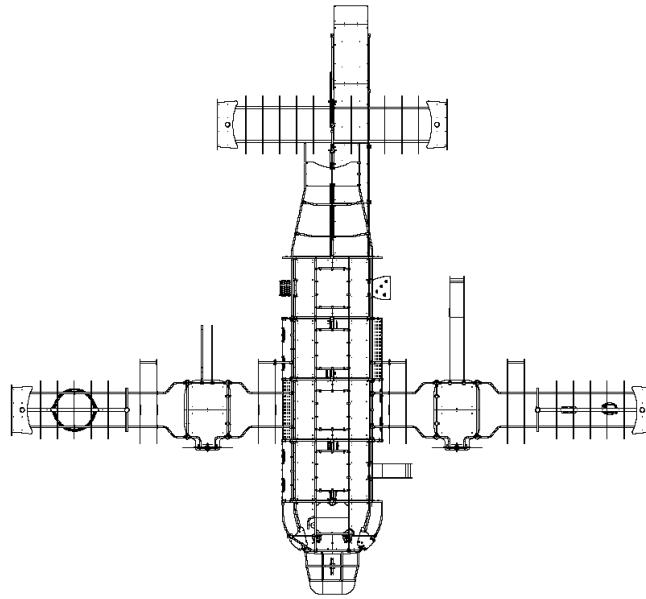



Installation de l'équipement

Zone d'impact : Surface de sol minimale requise

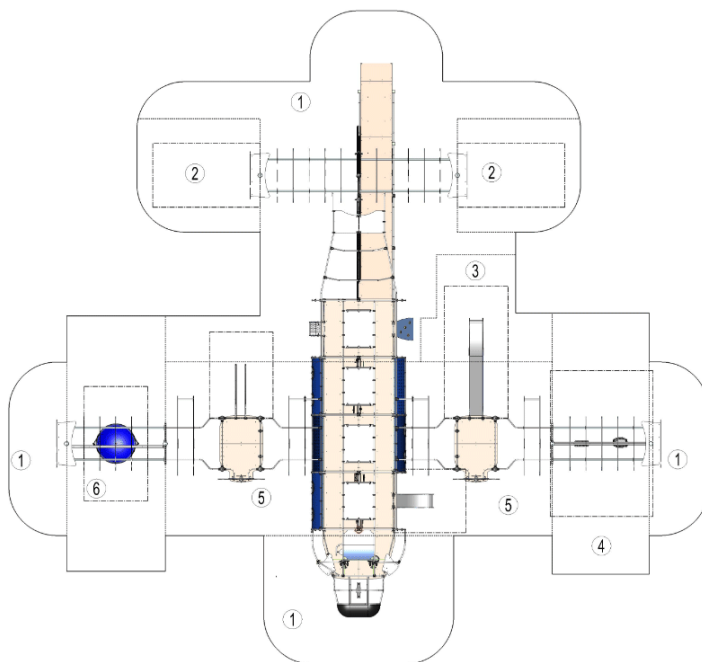
-  Zone d'impact
-  Espace libre



		
1	<0,6m	16m ²
2	0,7m	27m ²
3	1m	11m ²
4	1,4m	25m ²
5	1,77m	67m ²
6	2m	25m ²



4



40h00



0m³



260.5m²



4072kg



67kg

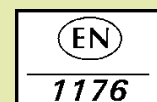

Proludic

2015-02-10