



6+

2

1,3m

1 = 2,73m 2 = 0,4m 3 = 1,57m

Privilégier une installation sur sols fluents.



Handicap moteur



Handicap sensoriel

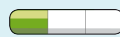

Handicap mental

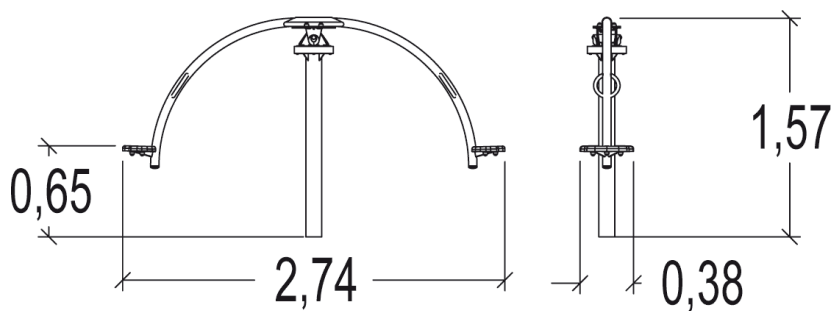

Fonctions ludiques : 2

s'Équilibrer



tourner



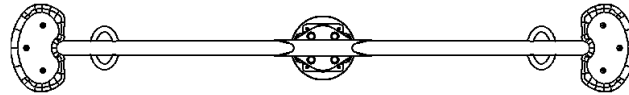



## Installation de l'équipement

**Zone d'impact : Surface de sol minimale requise**

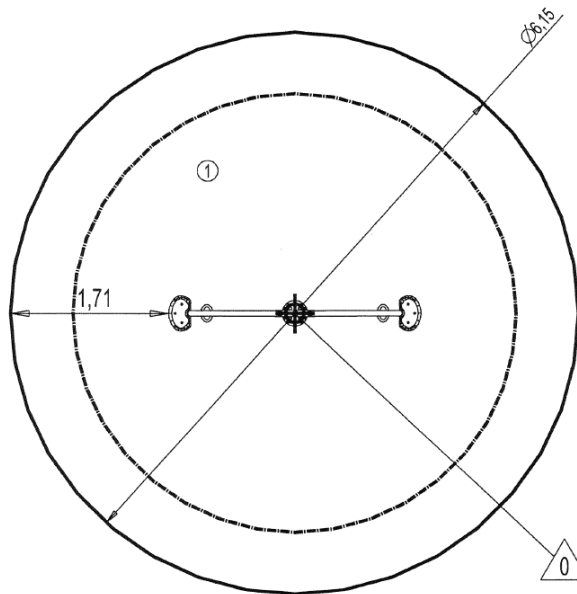
-  Zone d'impact
-  Espace libre



Point de Référence  
Setting Out Point  
Punto de referencia  
Bezugspunkt  
Referentiepunt

		
1	1,30m	30m <sup>2</sup>



2



03h00



0.3m<sup>3</sup>



30m<sup>2</sup>



79kg



32kg

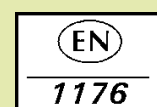

*Proludic*

2013-03-14